

# Scantech Polaris P-7010

## Scanner Page 1

This scanner is designed to connect to any ps/2 style keyboard and keyboard port. It can be connected to an AT style keyboard or keyboard port by means of an adapter. It can be used with the following terminals:

Serial Spot Line

Ethernet Spotline

Thin Client

This is the proper setup for the Scantech Polaris P-7010.  
Log out of the terminal and turn the power off before setting up the scanner.

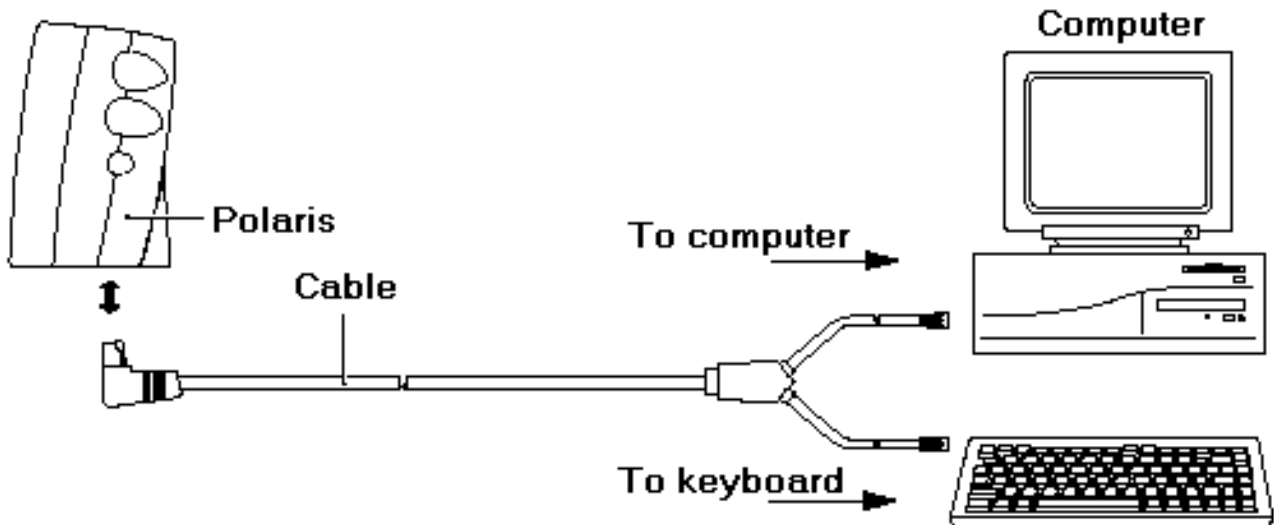

# Scantech Polaris P-7010

## Scanner Page 2

Before scanning the following barcode you will need to press the button on the top of the scanner. Hold down the button until you hear a beep

### **Return to Custom Default Settings**

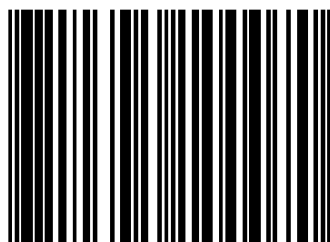

**1.4**

Press and hold the button on the top of the scanner until you hear a beep before scanning the next barcode.

### **Transmit EAN13 Check Digit off**

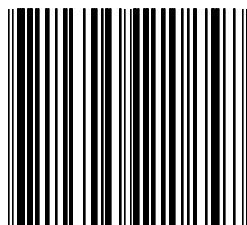

### **Transmit EAN8 Check Digit Off**

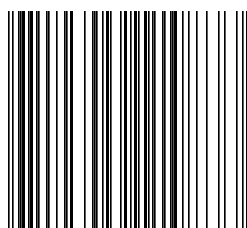

# Scantech Polaris P-7010 Scanner Page 3

**Transmit UPCA Check Digit off**

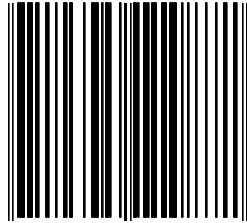

**Transmit UPCE Check Digit off**

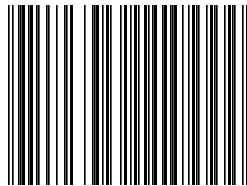

**Close Programming Mode with Update**



# Scantech Polaris P-7010

## Scanner Page 4

Press and hold the button on the top of the scanner until you hear a beep before scanning the next barcode.

### **Transmit first digit UPCA off**

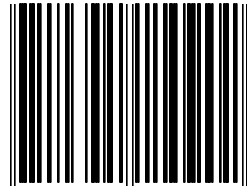

### **Close (with update) program mode**

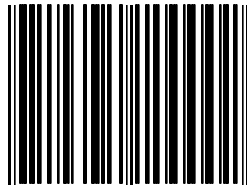

Press and hold the button on the top of the scanner until you hear a beep before scanning the next barcode.

### **Open Programming mode Postambles**

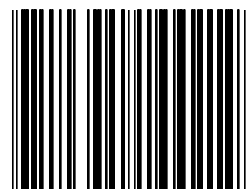

# Scantech Polaris P-7010

## Scanner Page 5

Scan the following code for two carriage returns. Skip the next barcode for one carriage return. If you are unsure if you need one or two carriage returns, scan for two.

### **Carriage Return**

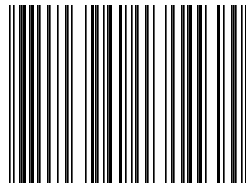

### **Carriage Return**

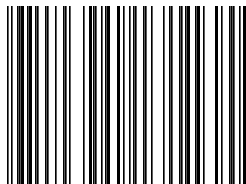

# Scantech Polaris P-7010

## Scanner Page 6

**Close Programming mode  
postambles with update**

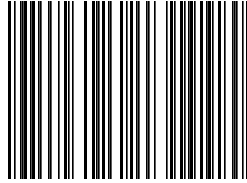

**Close (with Update) Program Mode**

